

MODAL TESTING OF A FLEXIBLE WING ON A DYNAMICALLY ACTIVE TEST FIXTURE USING THE FIXED BASE CORRECTION METHOD – IFASD 2019

Natalie Spivey¹, Kia Miller¹, Rachel Saltzman¹, and Kevin Napolitano²

¹ NASA Armstrong Flight Research Center
Edwards, California 93523 USA
Natalie.D.Spivey@nasa.gov
Kia.D.Miller@nasa.gov
Rachel.Saltzman@nasa.gov

² ATA Engineering, Inc.
San Diego, California 92128 USA
Kevin.Napolitano@ata-e.com

Keywords: fixed base correction, flexible wing, frequency response function, ground vibration test, modal test, structural dynamics

Abstract: In modal testing and finite element model correlation, analysts desire modal results using free-free or rigid boundary conditions to ease comparisons of test versus analytical data. It is often expensive both in cost and schedule to build and test with boundary conditions that replicate the free-free or rigid boundaries. Static test fixtures for load testing are often large, heavy, and unyielding, but do not provide adequate boundaries for modal tests because they are dynamically too flexible and often contain natural frequencies within the test article frequency range of interest. The dynamic coupling between the test article and test fixture complicates the model updating process because significant effort needs to be spent on modeling the test fixture and boundary conditions in addition to the test article. If the modal results could be corrected for fixture coupling, then setups used for other structural testing could be adequate for modal testing and would allow significant schedule and cost savings by eliminating a unique setup for only modal testing. To simplify future modal tests, this paper reports on a fixed base correction method that was investigated during modal testing of a full-scale, half-span, flexible wing cantilevered from a static test fixture. The results of this fixed base correction approach look very promising. The method aided in producing similar wing modal characteristics for two different physical boundary configurations of a dynamically active test fixture.

1 INTRODUCTION

New aircraft structures often require both static and dynamic structural ground testing to verify the analytical structural finite element models (FEMs) used in determining airworthiness. Static and dynamic ground tests require different boundary conditions which result in costly test setups. Often component tests are performed to aid the analysis by characterizing parts of the aircraft before final assembly. This component testing can reduce impact to the critical chain of the project schedule, yet it often will require specialized boundary conditions and therefore can result in costly, specialized test fixtures. The costs of the specialized test fixtures include engineering effort and manufacturing.

More importantly, however, schedule costs are considerable since it takes time to mount and demount the test article for a single modal survey. Therefore, it would be beneficial if a fixed

base modal survey could be conducted while a test article is mounted in a static test fixture for a different ground test, allowing for two traditionally separate structural tests to be performed on one mounting fixture. This paper discusses the Flight Loads Laboratory (FLL) effort to apply a fixed base correction (FBC) technique to measure fixed base modes from a test article mounted to a dynamically active static test fixture.

The FLL at the National Aeronautics and Space Administration (NASA) Armstrong Flight Research Center (Edwards, California) specializes in both structural modal testing and loads calibration testing of aerospace research structures [1]. To facilitate an upcoming loads calibration test on the Passive Aeroelastic Tailored (PAT) wing, the FLL had a wing loads test fixture (WLTF) designed as shown in figure 1. The PAT wing test article was a carbon-epoxy, semi-span of approximately 39 ft, high aspect ratio wing using a newer composite technology known as tow-steering fibers [2–4]. Due to the size of the PAT wing, the need for an additional modal test setup using conventional free-free or rigid boundary conditions was costly and inefficient. Instead, a FBC method developed by ATA Engineering, Inc. (San Diego, California) was investigated to decouple the wing and fixture modes to allow the modal test to be performed on the dynamically active WLTF. Prior to the PAT wing modal test, a pathfinder modal test was performed on a similar sized wing known as the Calibration Research Wing (CReW) which was mounted in the WLTF for testing to investigate and ensure the FBC method would be successful for the PAT wing test article. This paper focuses on the results from the modal testing of the CReW test article.

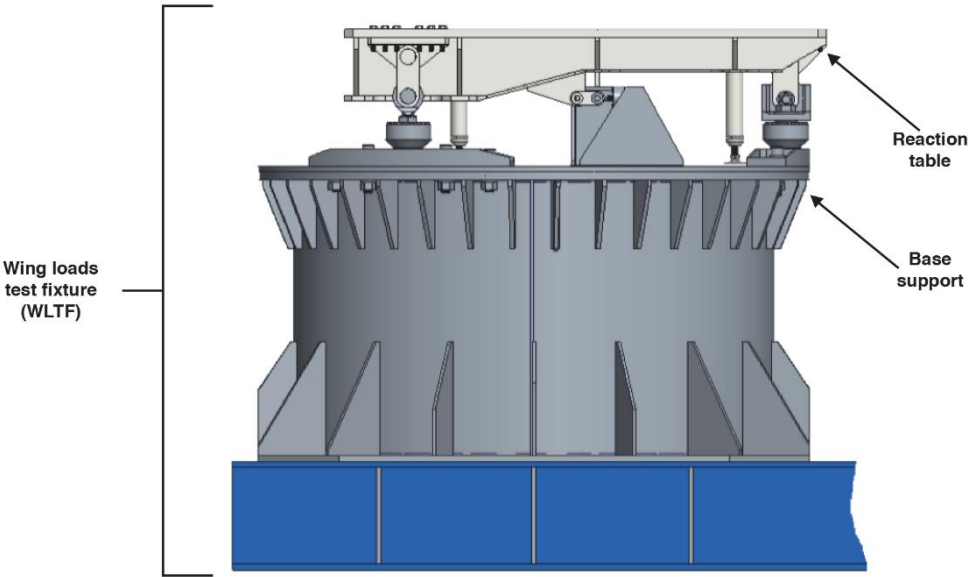

Figure 1: Side view of a wing loads test fixture (WLTF) – dynamically active static test fixture.

2 THEORY / CORRECTION METHODOLOGY

There has been considerable literature discussing how to extract fixed base modes from structures, mainly satellite related structures, mounted on shake tables [5–13]. These methods take two different approaches to extract fixed base modes from structures mounted on flexible shake tables. One method applies a constraint equation to measure mass-normalized mode shapes to generate fixed base modes [14]. The advantage of using mass-normalized modes is that a large number of shakers do not necessarily need to be mounted on the base. The disadvantage is that the accuracy is reduced if the fixed base modes are not a linear combination of the measured mode shapes. The method also requires well-excited modes so that modal mass

can be accurately calculated. A second method, hereafter called the fixed base correction (FBC) method, is the focus of this paper and uses base accelerations as well as constraint shapes as references to calculate frequency response functions (FRFs) associated with a fixed base [15–16]. The FRFs are then analyzed to extract fixed based modes of the test article.

The FBC method can be illustrated with a simple spring-mass two degree-of-freedom (DOF) system shown in figure 2.

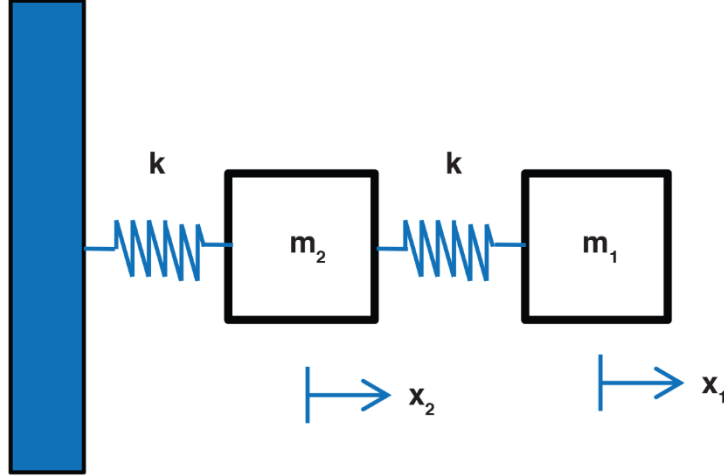

Figure 2: Spring-mass two degree-of-freedom system.

Applying Newton's second law, the equation of motion for an undamped system in the frequency domain is shown in equation (1):

$$\begin{bmatrix} -\omega^2 m_1 + k & -k \\ -k & -\omega^2 m_2 + 2k \end{bmatrix} \begin{Bmatrix} x_1 \\ x_2 \end{Bmatrix} = \begin{Bmatrix} f_1 \\ f_2 \end{Bmatrix} \quad (1)$$

Where m is the mass, ω is the frequency, k is the structural stiffness, x is the displacement, and f is the external force. The superscripts 1 and 2 refer to blocks 1 and 2, respectively.

The FRF for traditional modal testing is calculated using the forces applied to DOFs 1 and 2 as references to obtain the full system response shown in equation (2).

$$a_1 = \begin{bmatrix} \frac{-\omega^2(-\omega^2 m_2 + 2k)}{(-\omega^2 m_2 + 2k)(-\omega^2 m_1 + k) - k^2} & \frac{-\omega^2 k}{(-\omega^2 m_2 + 2k)(-\omega^2 m_1 + k) - k^2} \end{bmatrix} \begin{Bmatrix} f_1 \\ f_2 \end{Bmatrix} \quad (2)$$

Where a is the acceleration.

However, for implementing the FBC method, if one uses the force at DOF 1 and the acceleration at DOF 2 as references shown in equation (3), then the resulting FRFs are associated with a structural system with dynamics associated with DOF 2 fixed.

$$a_1 = \begin{bmatrix} \frac{-\omega^2}{-\omega^2 m_1 + k} & \frac{k}{-\omega^2 m_1 + k} \end{bmatrix} \begin{Bmatrix} f_1 \\ a_2 \end{Bmatrix} \quad (3)$$

Furthermore, the FRF associated with the applied force at DOF 1 is equivalent to the FRF of a fixed base system.

The key to the FBC method is to have at least one independent excitation source, usually modal shakers, for each DOF that is desired to be fixed. Therefore, FBC modal testing requires multiple shakers used on both the test article and test fixture. Although not used in this paper, constraint shapes could be used as references when the number of independent sources is larger than the number of independent DOFs of the test fixture. The fundamental FBC strategy is to use shaker accelerations as references rather than the traditional shaker forces when calculating FRFs.

3 TEST DESCRIPTION

The objective of the CReW modal testing was to measure the primary wing frequencies and mode shapes using the FBC method. The modal test setup, test configurations, instrumentation, and accelerometer and shaker layouts will be described in the following sections.

3.1 Test Article

The CReW test article is a composite, full-scale, half-span flexible wing with an approximate length of 32 ft and weight of 450 lb as shown in figure 3. The CReW has a similar span size as the PAT wing.



Figure 3: Calibration Research Wing (CReW).

3.2 Modal Test Setup

The modal test with the CReW mounted to the dynamically active WLTF was the pathfinder test for the PAT wing modal test and took place in the summer of 2017 in the NASA Armstrong FLL high bay. The WLTF consists of the base support and a reaction table, as seen back in the Introduction section in figure 1. The reaction table is supported on top of the base support by seven single axis load cells and four retractable feet which contact the base support as shown in figure 4, where only a few load cells and retractable feet are shown due to the view of figure 4. The CReW wing root was cantilevered from the reaction table with four aircraft pins to secure the wing spars to a simulated wingbox containing four C-channels connected with a top plate which was secured to the reaction table as shown in figure 5. The wingtip was

approximately 8.5 ft above the lab floor which complicated some of the modal test setup as shown in figure 6.



Figure 4: WLTF reaction table supported with 4 retractable feet (2 shown) and 7 load cells (4 shown).

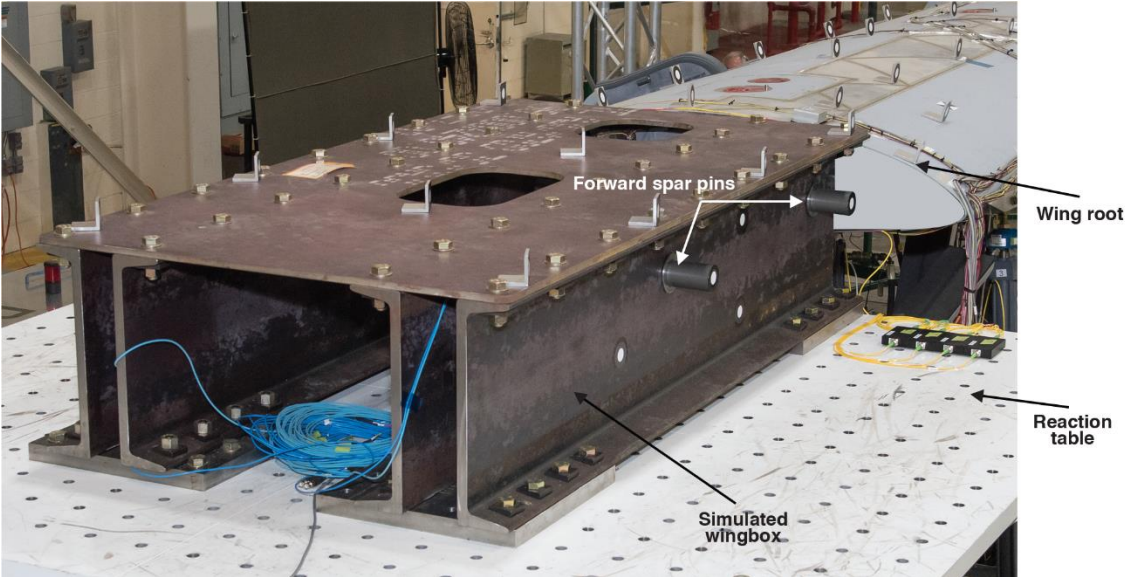

Figure 5: Wing root secured to reaction table.



Figure 6: Modal test setup with CRW mounted on the WLTF with wingtip ≈ 8.5 ft above lab floor.

3.3 Modal Test Configurations

As described in section 3.2 Modal Test Setup, the WLTF reaction table is supported by seven load cells and four retractable feet on the WLTF base support. To investigate the FBC method the CReW ground vibration testing (GVT) was performed in two different configurations, one with the four retractable feet up and one with the four retractable feet down. Therefore, two slightly different boundary conditions were provided on the reaction table as shown in figure 7. The FBC method attempted to “fix” the reaction table or make the reaction table rigid with the different retractable feet boundary conditions and decouple the wing modes from the WLTF modes.

CReW GVT had two different test configurations of the reaction table feet for the FBC method:

- Feet up configuration
- Feet down configuration

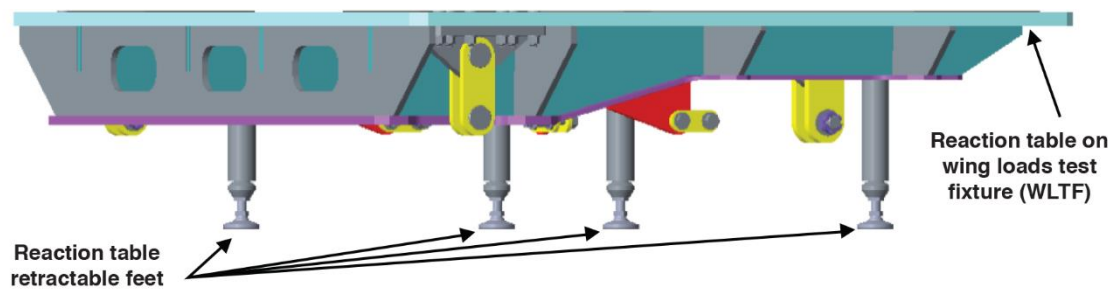

Figure 7: Different reaction table boundary conditions – retractable Feet up and down.

3.4 Modal Test Instrumentation

Traditional modal testing normally requires accelerometers with a sensitivity of 100 mV/g distributed over the test article and force transducers at the shaker locations. The only additional sensors needed to implement the FBC method compared to a traditional modal test include additional 100 mV/g accelerometers on the hardware being “fixed” and a small handful of seismic uniaxial accelerometers, which typically have a sensitivity of 1000 mV/g. These seismic accelerometers with the higher sensitivity were used at each shaker location on the hardware being fixed, so the shaker accelerometer data could be as clean as possible for use as the references in the FBC method instead of the traditional shaker forces being used as references for the FRFs [15–16]. The CReW GVT used three different types of accelerometers as shown in figure 8, depending on whether a uniaxial or triaxial accelerometer was desired to measure a certain number of DOFs at each location along with the seismic accelerometers at the fixed shaker locations.



Figure 8: Ground test accelerometers used for CReW modal testing (not to scale).

Every place a shaker was installed around the reaction table, there was a reference seismic accelerometer in the direction of the shaker excitation along with a force transducer at the end

of each shaker stinger. See figure 9 for an example of the seismic accelerometer and force transducer shaker setup that was only used on the reaction table. The wingtip shaker did not require a seismic accelerometer because the force was used as a reference when calculating the FRF.

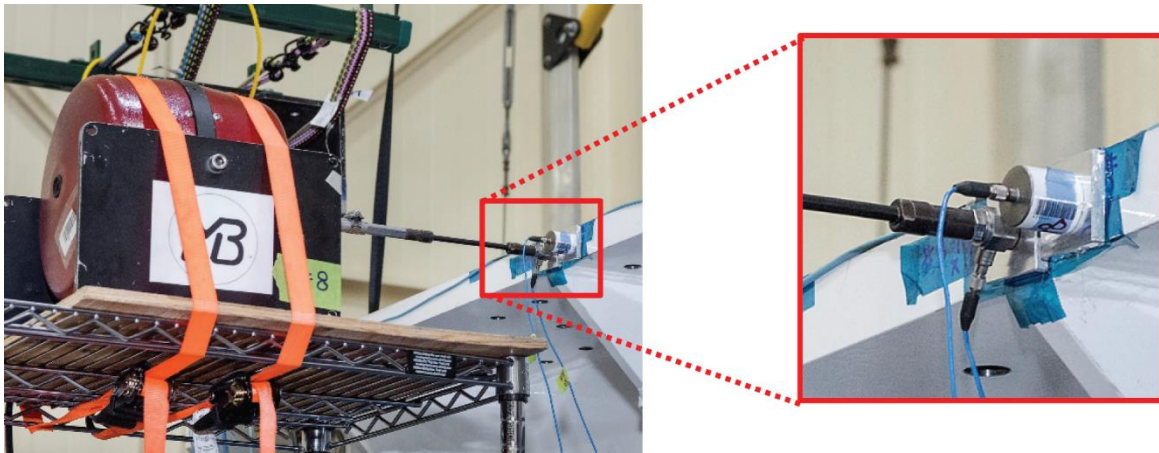

Figure 9: Typical shaker set-up on the WLTF reaction table using seismic accelerometer.

3.5 Modal Test Accelerometer Layout

The CReW modal test included accelerometers on the wing like traditional modal testing, but implementing the FBC method also required numerous accelerometers on the WLTF reaction table and the simulated wingbox hardware connected to the reaction table. The CReW GVT used a total of 41 different accelerometer locations for measuring 117 DOF responses in order to acquire the desired mode shapes of the wing and test fixture needed to implement the FBC technique. The data acquisition system also had to allocate for the 10 shaker force transducers measured as references and the 10 shaker seismic accelerometers measured as responses and later used as references for the FBC method. There was a total of 137 channels recorded with the data acquisition system for each test.

Of the 41 total locations there were only 14 accelerometer locations on the wing and wing spars; see figure 10 which used triaxial accelerometers to measure a total of 42 DOFs for the wing. The wing sensor placement method is the same for any modal survey test; sensors should be placed to adequately observe and differentiate modes of a structure. To ease the wing accelerometers installation, the sensors were installed prior to mounting the wing onto the WLTF.

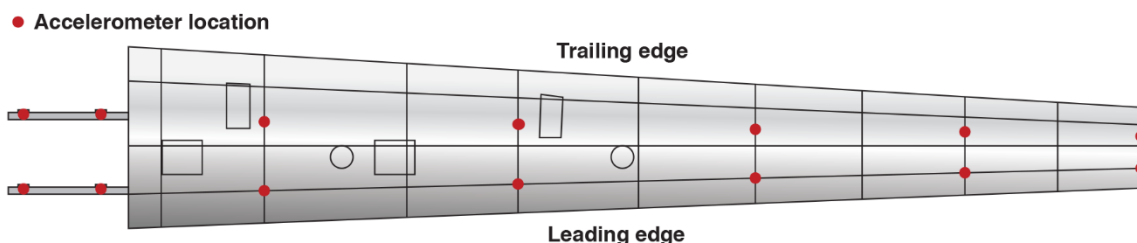

Figure 10: Accelerometer locations on the wing.

The remaining 27 locations were on the WLTF reaction table and the simulated wingbox hardware in order to do the FBC calculations. The majority of these locations used triaxial accelerometers for a total of 75 DOFs measured on the hardware being fixed as shown in

figure 11. It should be noted that in figure 11 many of the accelerometer locations are hidden from view.

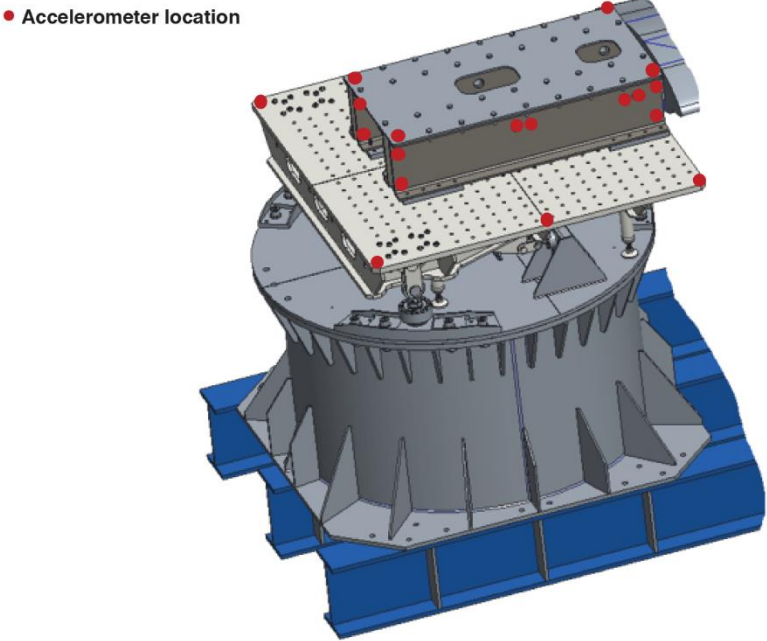

Figure 11: Accelerometer locations on the WLTF.

3.6 Modal Test Shaker Layout

The FBC method requires multiple independent drive points (shakers) to be mounted to both the WLTF hardware and the CReW test article. The shaker layout depends on where the FBC technique is trying to fix the boundary conditions. There needs to be at least as many independent sources as there are independent boundary deformations of the desired fixed hardware in the test article frequency range of interest. The CReW GVT fixed the WLTF at the reaction table boundary. One shaker was positioned on the wingtip as shown in figure 12 like traditional modal testing, and nine other shakers were around the WLTF reaction table.



Figure 12: CReW wingtip shaker.

The direction of the shakers on the reaction table is important and essentially eliminates the effect of the reaction table from moving in each shaker direction. A few different shaker configurations were attempted to find the final or optimal shaker configuration which fixed the reaction table. The final shaker layout consisted of ten total shakers with the one wingtip shaker and nine shakers around the reaction table as shown in figure 13 and fixed nine DOFs on the reaction table. The placement of the shakers around the WLTF was adjusted to excite primary base modes and maximize the capability of the FBC to decouple the base modes from the wing modes. One may notice in figure 13 that shaker 10 is missing, but there is a shaker 11 because shaker 10 was in a previous location on the reaction table which did not suppress any motion. The shakers used were Modal 110 lb electromagnetic shakers (MB Dynamics Inc., Cleveland, Ohio) and were supported by various types of shaker support stands along with some shakers suspended by bungees from modified multi-purpose lifts as shown in figures 14 and 15. Higher shaker forces were required on the reaction table than what was required at the wingtip.

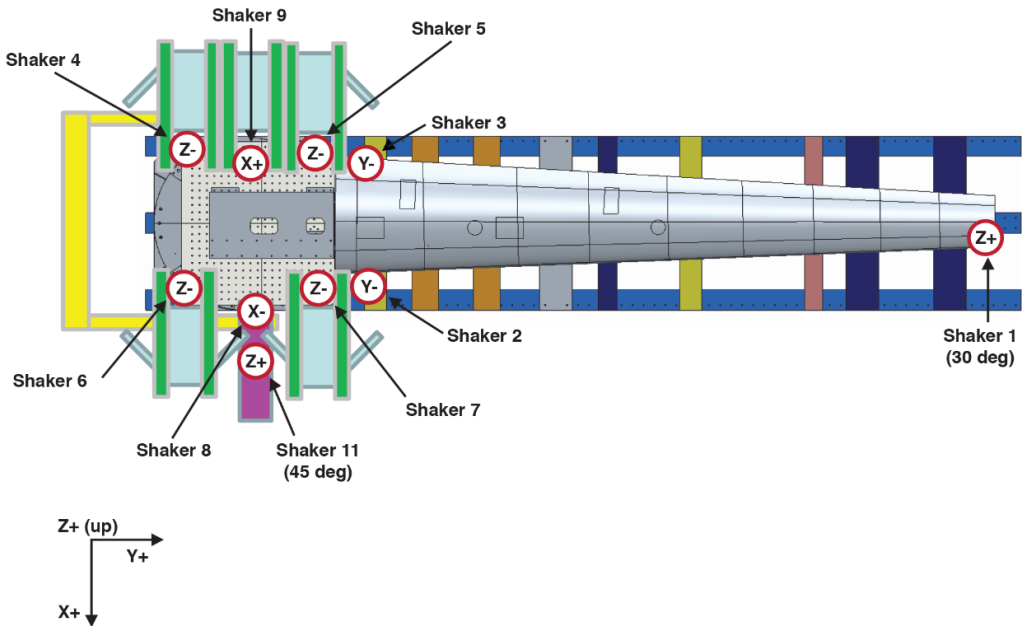

Figure 13: CRew GVT shaker layout for the FBC method.

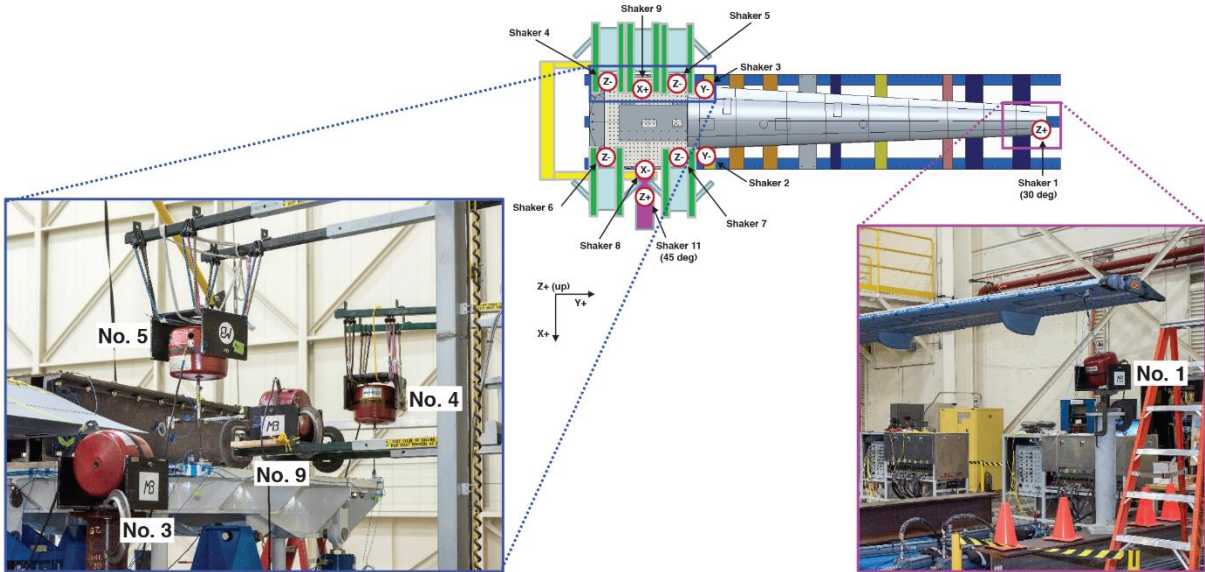

Figure 14: Shaker set-up around the WLTF reaction table.

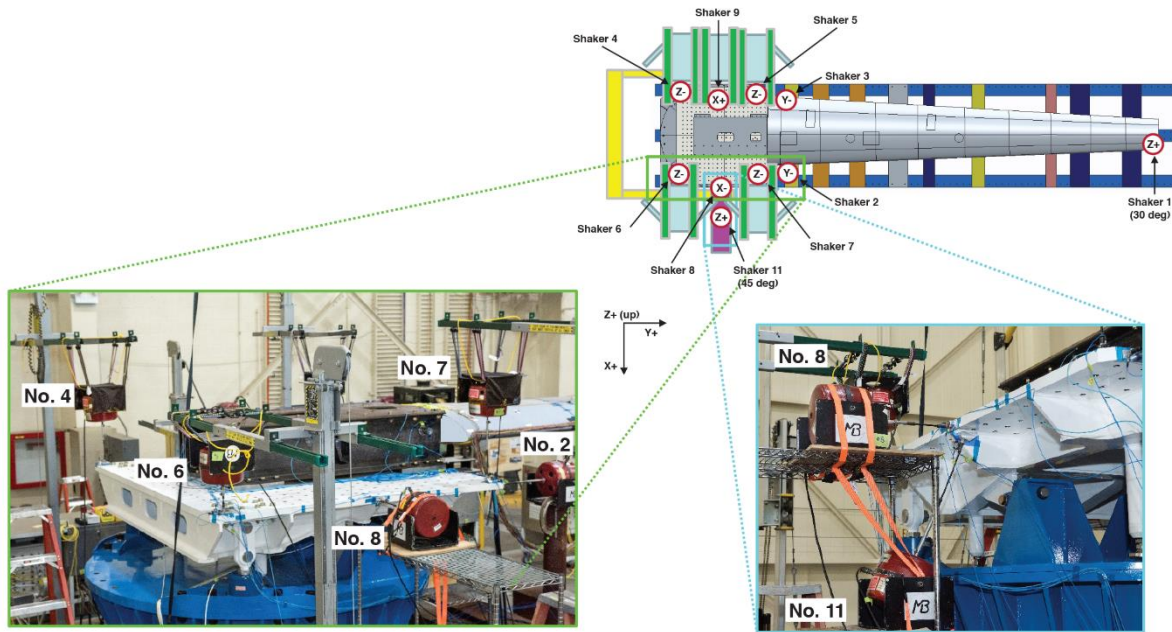

Figure 15: Shaker set-up around the WLTF reaction table.

4 RESULTS

The CREW modal results tentatively showed that FBC modes were successfully extracted using a total of ten shakers. The shakers around the WLTF were placed to excite all rigid body motion of the reaction table and to excite the in-plane bending of the C-channels, and the wingtip shaker was placed to excite the wing modes.

4.1 Feet Up Configuration: Uncorrected Versus Fixed Base Correction Results

The wingtip driving point FRFs for this ten shaker, Feet up configuration for the uncorrected and corrected results are shown in figure 16. The wing bending (B), torsion (T), and fore/aft (F/A) modes are called out on the figures below with the blue line as the uncorrected FRF and the orange line as the FBC FRF. It can be seen that the bending modes coupled the least with the WLTF boundary condition since the WLTF is stiffer vertically than in other directions. The fore/aft and torsion wing modes coupled the most with the WLTF and required significant correction, as shown by the frequency shifts in figure 16 when using FBC. The frequency shifts are particularly notable for the wing 1st fore/aft mode, the wing 2nd fore/aft mode, and the wing 1st torsion mode.

Another significant effect of using the FBC technique can be seen in figure 16 by the peaks showing two reaction table base plate modes. The uncorrected FRF shows these two modes where the base was excited: a wing 1st torsion mode with a plate twisting motion on the reaction table (W1T plate twist), and a wing 4th bending mode with a dive plate motion on the reaction table (W4B plate dive). The FBC FRF in figure 16 shows that both of these plate mode peaks disappear when using the FBC method, which shows some promise that the method is adequate for removing the effects of base motion from the GVT results.

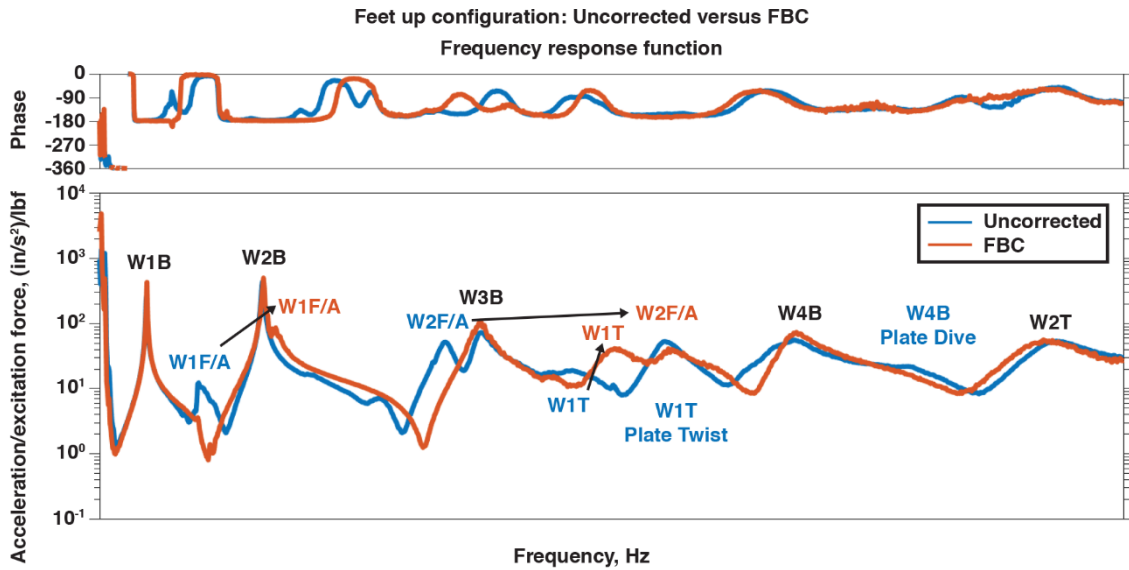

Figure 16: Feet up configuration with 10 shakers.

Another promising sign of the effectiveness of the FBC method is shown in figure 17, which presents a comparison between the uncorrected and corrected wing fore/aft bending modes on the test display model. The uncorrected mode shapes are shown on the left, while the FBC mode shapes are shown on the right. Any base motion is primarily shown by the pink, red, and green dashed lines in the zoomed-in regions. The FBC mode shapes show very little base deflection. In contrast, the uncorrected mode shapes show the base rotating a significant amount; most of this base motion can be seen in the yellow plate as well as the red plates. The wing 2nd fore/aft mode appears to have more base motions than the wing 1st fore/aft mode for the uncorrected mode shapes. From these observations, it could be inferred that the fixed base correction method was able to remove a majority of the dynamics of the static test fixture to acquire fixed base modes while still accurately measuring the shape of the wing.

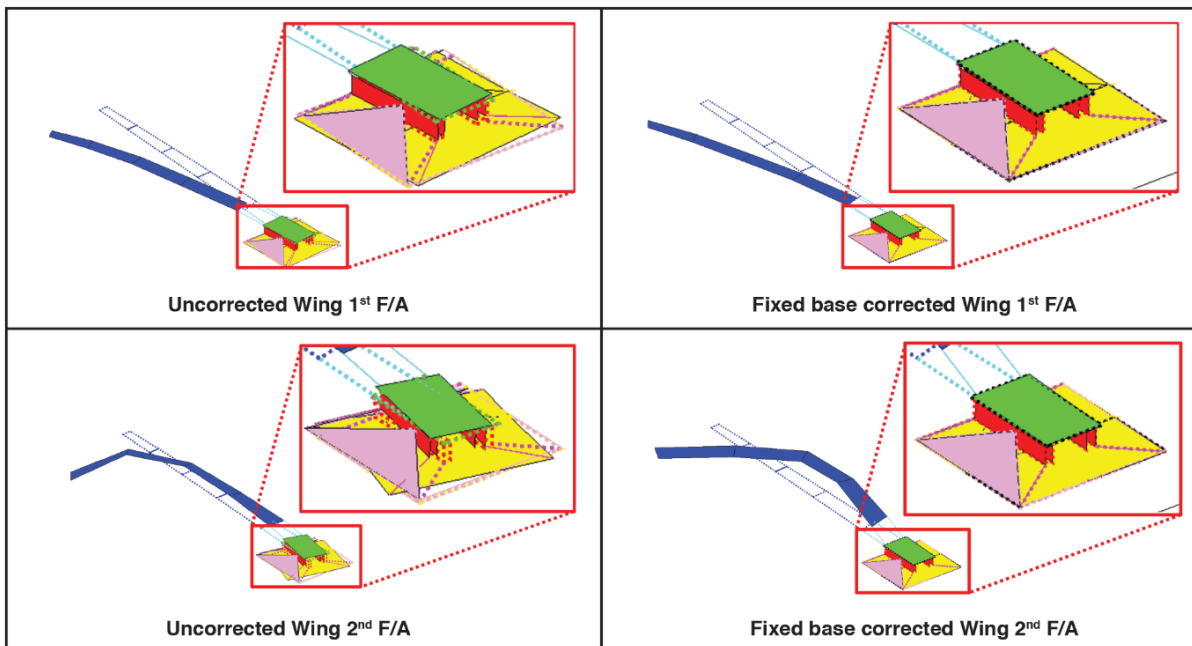

Figure 17: Uncorrected and corrected wing first and second fore/aft mode shapes.

The uncorrected FRF in figure 16 shows the peaks of two base modes. The second base mode is the plate dive mode of the reaction table with wing 4th bending as seen in figure 18. It is significant that this mode and the other plate mode both disappear when applying the FBC method, showing that the method is able to remove base excitation and more cleanly show the motion of the wing mode shapes.

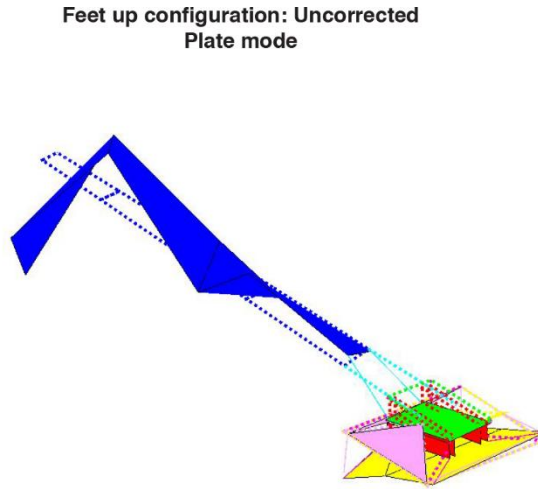

Figure 18: Wing 4th bending with reaction table dive plate – mode disappears with FBC.

4.2 Feet Down Configuration: Uncorrected Versus Fixed Base Correction Results

The wingtip driving point frequency response function for this ten shaker, Feet down configuration for the uncorrected and corrected results are shown in figure 19. The net result of putting the feet down was to move the uncorrected wing torsion modes closer to the corrected wing torsion modes.

Having the feet down helped stiffen the wing torsion modes, but did little to stiffen the wing bending and fore/aft modes. Essentially, using the accelerations of the four vertical shakers on the reaction table corners (shakers 4-7, shown in figures 14 and 15) as references fixed the corners of the table in the vertical direction for the Feet up boundary condition, which meant that adding the four vertical supports did not help to further stiffen the base.

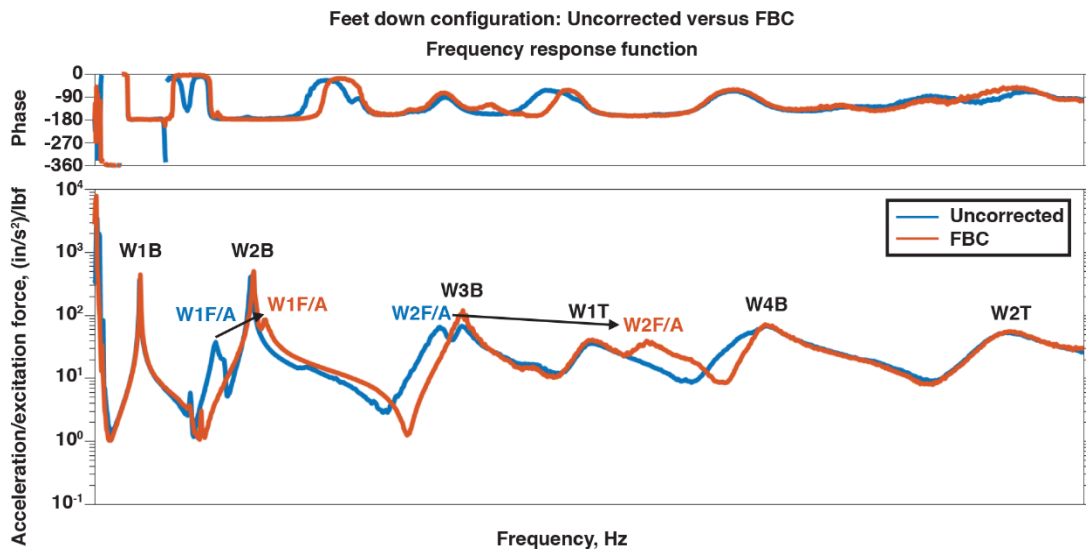

Figure 19: Feet down configuration with 10 shakers.

4.3 Feet Up Configuration Versus Feet Down Configuration: Uncorrected and FBC Results

The wingtip driving point FRF for this ten shaker configuration for the Feet up and Feet down uncorrected results are shown in figure 20. Several of the wing fore/aft and torsion modes are located at very different locations in the FRF due to their differences in boundary conditions.

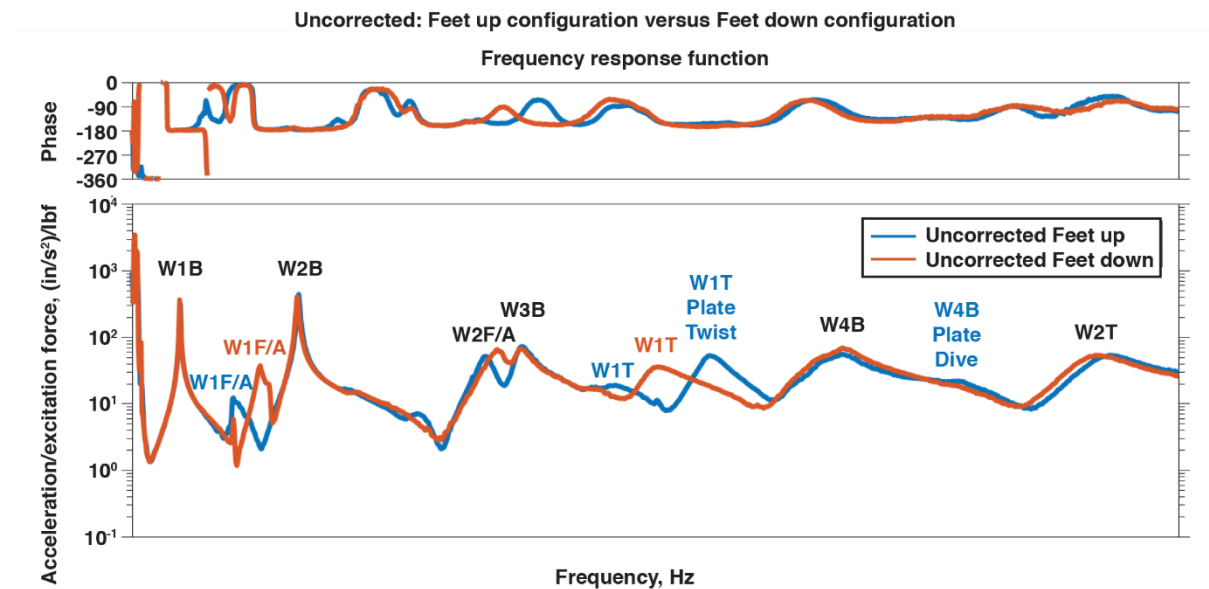

Figure 20: Uncorrected (Feet up and Feet down configurations) with 10 shakers.

In contrast with figure 20, the wingtip driving point FRF for the Feet up and Feet down FBC results are lined up very well as shown in figure 21. The phases and magnitudes of the FBC FRFs look very similar and have corresponding frequency peaks. It is important to note that the FBC approach was able to aid two different physical table boundary configurations (Feet up versus Feet down) to produce equivalent wing modal results. Table 1 shows that the FBC frequencies for both Feet up and Feet down are very similar, while there are some large differences in frequencies for the uncorrected results. The wing 1st fore/aft mode showed the largest changes; the FBC method reduced the percent difference of two different test configurations from 21.3 percent (Uncorrected) to only 0.04 percent (FBC). The wing 1st torsion mode also showed significant improvement, with the difference reduced from 8.5 percent (Uncorrected) to only 0.02 percent (FBC). These results show that the FBC technique has potential for simplifying modal test setup boundary conditions by giving more options in choosing boundary conditions while still giving accurate results.

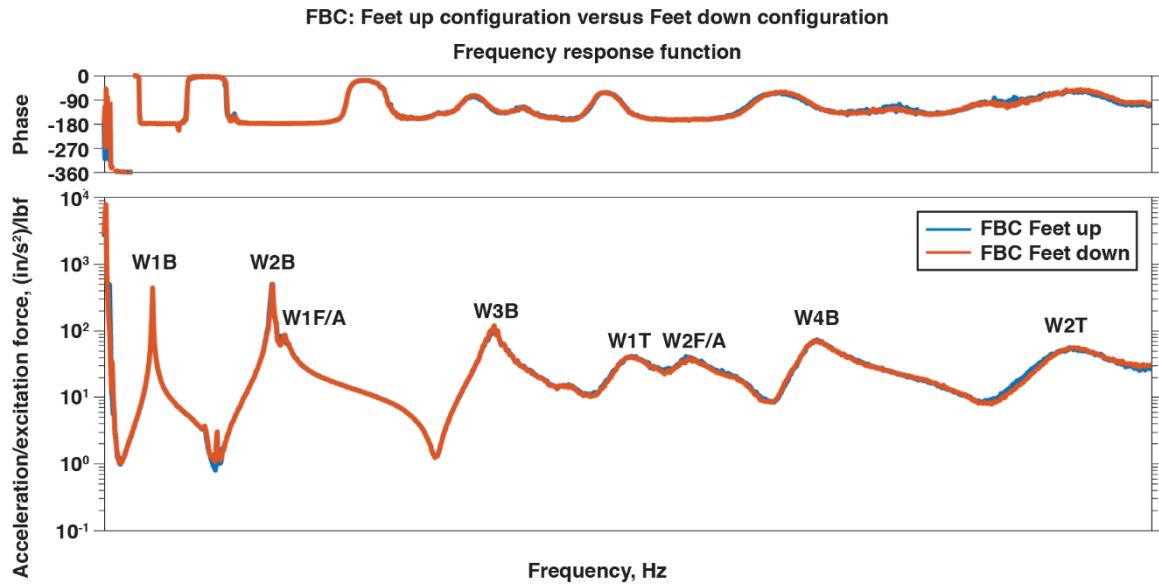

Figure 21: FBC method (Feet up and Feet down configurations) with 10 shakers.

Table 1: Comparing FBC (Feet up and Feet down) frequency differences.

No.	Description	Description	Percent difference, Uncorrected: Feet up and Feet down frequency results	Percent difference, FBC: Feet up and Feet down frequency results
1	Wing 1 st bending	W1B	0.4	0.05
2	Wing 2 nd bending	W2B	0.8	-0.45
3	Wing 1st fore/aft	W1F/A	-21.3	-0.04
4	Wing 3 rd bending	W3B	0.1	-0.03
5	Wing 1st torsion	W1T	-8.5	0.02
6	Wing 2nd fore/aft	W2F/A	-3.1	0.12
7	Wing 4 th bending	W4B	0.3	-0.04
8	Wing 2nd torsion	W2T	1.3	-0.36

5 SUMMARY

This paper has presented the Calibration Research Wing modal results and shown the feasibility of using the fixed base correction (FBC) method to decouple the wing and test fixture modes for a long flexible wing mounted to a dynamically active static test fixture. The key to the FBC method is to apply an excitation to the desired fixed boundary hardware with multiple independent sources (that is, shakers) where there are at least as many independent sources as there are independent boundary deformations in the test article frequency range of interest. The FBC method then uses the shaker boundary accelerations (that is, accelerations from seismic accelerometers) as independent references when calculating the frequency response functions. This FBC method has the potential to change how modal testing is traditionally done and will save projects cost and schedule time by no longer needing an independent setup for modal testing. The FBC results also produce test results with reliable boundary conditions to replicate in analytical models. The lessons learned during this testing will be used to extend the FBC technique to the Passive Aeroelastic Tailored wing test article and assist in giving analysts an accurate set of fixed base modes for use in model correlation.

6 ACKNOWLEDGEMENTS

The authors gratefully acknowledge NASA's Advanced Air Transport Technology (AATT) project for their funding support to accomplish this CReW testing as a pathfinder test to support the PAT wing modal testing. The PAT wing is under the AATT project of NASA's Advanced Air Vehicles Program (AAVP). We also thank the NASA Armstrong Flight Loads Laboratory technicians and mechanics for their assistance in setting up and performing the CReW ground vibration test. Finally, the NASA authors thank ATA Engineering, Inc. in San Diego, California, for assisting with the testing and guidance through the post-test data analysis using the fixed base correction method.

7 REFERENCES

- [1] NASA Armstrong Flight Loads Laboratory, URL: <https://www.nasa.gov/centers/armstrong/research/Facilities/FLL>, accessed, April 4, 2019.
- [2] Brooks, T. R., Kennedy, G. J., and Martins, J. R. R. A. (2016). High-fidelity aerostructural optimization of a high aspect ratio row-steered wing. AIAA-2016-1179, *Proceedings of the 57th AIAA/ASCE/AHS/ASC Structures, Structural Dynamics, and Materials Conference, AIAA SciTech Forum*, San Diego, California.
- [3] Brooks, T. R., Kennedy, G. J., and Martins, J. R. R. A. (2017). High-fidelity multipoint aerostructural optimization of a high aspect ratio tow-steered composite wing. AIAA-2017-1350, *Proceedings of the 58th AIAA/ASCE/AHS/ASC Structures, Structural Dynamics, and Materials Conference, AIAA SciTech Forum*, Grapevine, Texas.
- [4] Brooks, T. R., Kenway, G. K. W., and Martins, J. R. R. A. (2018). Benchmark aerostructural models for the study of transonic aircraft wings. *AIAA Journal*, 56(7), 2840–2855.
- [5] Crowley, J. R., Klosterman, A. L., Rocklin, G. T., and Vold, H. (1984). Direct structural modification using frequency response functions. *Proceedings of the 2nd International Modal Analysis Conference*, Orlando, Florida.
- [6] Beliveau, J. G., Vigneron, F.R., Soucy, Y., and Draisey, S. (1986). Modal parameter estimation from base excitation. *Journal of Sound and Vibration*, 107(3), 435–449.
- [7] Imregun, M., Robb, D. A., and Ewins, D. J. (1987). Structural modification and coupling dynamic analysis using measured FRF data. *Proceedings of the 5th International Modal Analysis Conference*, London, England.
- [8] Carne, T. G., Martinez, D. R., and Nord, A. R. (1989). A comparison of fixed-base and driven base modal testing of an electronics package. *Proceedings of the 7th International Modal Analysis Conference*, Las Vegas, Nevada.
- [9] Fullekrug, U. (1996). Determination of effective masses and modal masses from base-driven tests. *Proceedings of the 14th International Modal Analysis Conference*, Dearborn, Michigan.
- [10] Sinapius, J. M. (1996). Identification of fixed and free interface normal modes by base excitation. *Proceedings of the 14th International Modal Analysis Conference*, Dearborn, Michigan.
- [11] Mayes, R. L., and Bridgers, L. D. (2009). Extracting fixed base modal models from vibration tests on flexible tables. *Proceedings of the 27th International Modal Analysis Conference*, Orlando, Florida.
- [12] Allen, M. (2018). Recent advances to estimation of fixed-interface modal models using dynamic substructuring. *Proceedings of the 36th International Modal Analysis Conference*, Orlando, Florida.

- [13] Napolitano, K. L., and Yoder, N. C. (2012). Fixed base FRF using boundary measurements as references – analytical derivation. *Proceedings of the 30th International Modal Analysis Conference*, Jacksonville, Florida.
- [14] Mayes, R. L., Rohe, D. P., and Blecke, J. (2013). Extending the frequency band for fixed base modal analysis on a vibration slip table. *Proceedings of the 31st International Modal Analysis Conference*, Garden Grove, California.
- [15] Napolitano, K. L., Yoder, N. C., and Fladung, W. A. (2013). Extraction of fixed-base modes of a structure mounted on a shake table. *Proceedings of the 31st International Modal Analysis Conference*, Garden Grove, California.
- [16] Napolitano, K. L. (2019). Fixing degrees of freedom of an aluminum beam by using accelerometers as references. *Proceedings of the 37th International Modal Analysis Conference*, Orlando, Florida.

COPYRIGHT STATEMENT

The authors confirm that they, and/or their company or organization, hold copyright on all of the original material included in this paper. The authors also confirm that they have obtained permission, from the copyright holder of any third party material included in this paper, to publish it as part of their paper. The authors confirm that they give permission, or have obtained permission from the copyright holder of this paper, for the publication and distribution of this paper as part of the IFASD-2019 proceedings or as individual off-prints from the proceedings.